



Elastomer Products and Solutions

Extruded profiles, molded and manufactured parts

Sealing solutions to solve even
your most complex problems

In addition to CEFIL'AIR® inflatable seals, Technetics Group offers various elastomer sealing solutions according to your needs: extruded profiles, shaped parts, molded parts or parts molded over an insert (overmolded).

KEY ELASTOMER INFORMATION AND APPLICATIONS

(* other applications are possible, please contact us

	Nuances	Color	Density	Hardness	Temp (°C)	Data Sheet
Industrial Applications						
General use	C61	Grey		30 to 80 Shore	-50°C to 250°C	FT 915-115
	CM61	Red	0.3 to 0.7 gr/cm3		-50°C to 250°C	FT 915-075
High temperature	C61THT	Anthracite		30 to 80 Shore	-50°C to 250°C	FT 915-119
Hydrocarbon resistance	C62	Red		40 to 80 Shore	-50°C to 250°C	FT 915-014
Low temperature	C73	Red		50 to 70 Shore	-50°C to 250°C	FT 915-212
High mechanical properties	C65M	Red		50 to 70 Shore	-50°C to 250°C	FT 915-107
	C85M	Red		30 to 80 Shore	-50°C to 250°C	FT 915-155
(*)						
General use	EPDM 6B	Black		70 Shore	-30°C to 150°C	
Hydrocarbon resistance	NBR 3B	Black		70 Shore	-30°C to 150°C	
(*)						
Nuclear Applications						
High mechanical properties	C65M	Red		50 to 70 Shore	-50°C to 250°C	FT 915-107
	C85M	Red		30 to 80 Shore	-50°C to 250°C	FT 915-155
(*)						
General use	EPDM 6B	Black		70 Shore	-30°C to 150°C	
Hydrocarbon resistance	NBR 3B	Black		70 Shore	-30°C to 150°C	
(*)						
Aeronautic Applications						
Hydrocarbon resistance	CF61	Blue		40 to 80 Shore	-50°C to 250°C	FT 915-129
	CFM61	Blue	0.3 to 0.7 gr/cm3			FT 915-083
Conductive	C76					FT 915-097
Magnetic	C80					FT 915-
(*)						
General use	EPDM 6B	Black		70 Shore	-30°C to 150°C	
Hydrocarbon resistance	NBR 3B	Black		70 Shore	-30°C to 150°C	
(*)						
Oil and Gas Applications						
Hydrocarbon resistance	C62	Red		40 to 80 Shore	-50°C to 250°C	FT 915-014
(*)						
General use	EPDM 6B	Black		70 Shore	-30°C to 150°C	
Hydrocarbon resistance	NBR 3B	Black		70 Shore	-30°C to 150°C	
(*)						
Agri-food and Pharmaceutical Applications						
Food contact	C66	Translucent		30 to 80 Shore	-50°C to 250°C	FT 915-013
	CM66	Red	0.5 gr/cm3			FT 915-168
	C66DT	Brown		30 to 80 Shore	-50°C to 250°C	FT 915-184
Steam contact	C63	White		60 to 70 Shore	-50°C to 250°C	FT 915-182
USP Class VI	BIO-GUARDIAN®	White		60 Shore	-50°C to 250°C	FT 915-156
	C85M	Translucent		30 to 80 Shore	-50°C to 250°C	FT 915-155
(*)						
General use	EPDM 6B	Black		70 Shore	-30°C to 150°C	
Hydrocarbon resistance	NBR 3B	Black		70 Shore	-30°C to 150°C	
(*)						

Specific Applications (Contact Us)

Organic Elastomers

Silicone Elastomers

EXTRUDED PROFILES

Elastomers are naturally resistant to volume change when compressed. Consequently, to capture their elastic properties, profiles must be installed in such a way that they can expand laterally. However, this is impossible in many cases, so hollow or cellular profiles are used instead.

CHOOSING THE RIGHT PROFILE

The choice of profile is dictated by a compromise between the applied pressure and the travel: depending on the desired travel, the existing tolerances and the compressive force, the following types of seals are generally considered.

1. Profile for minimal travel and maximal compressive force

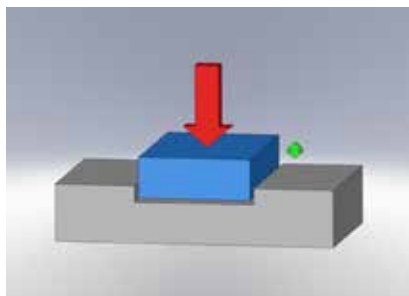

4. Profile for significant travel and weak compressive force

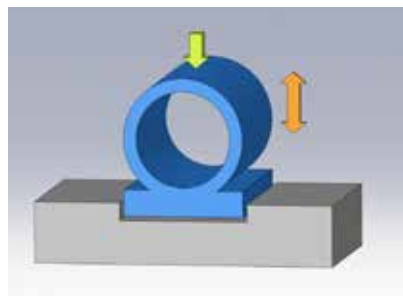

2. Profile for short travel and high compressive force

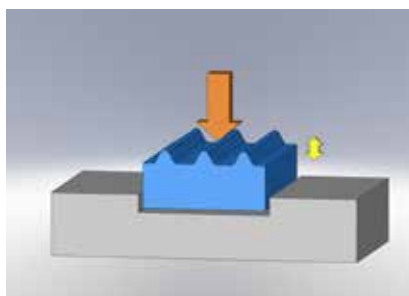

5. Profile for medium travel and weak compressive force

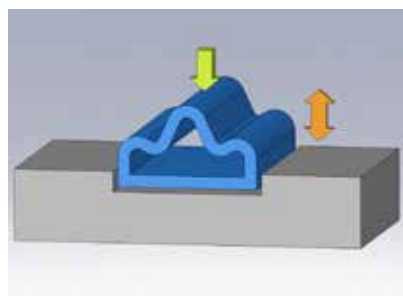

3. Profile for significant travel and medium compressive force

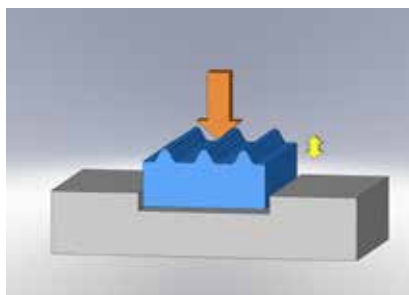

6. Profile for significant travel and minimal compressive force

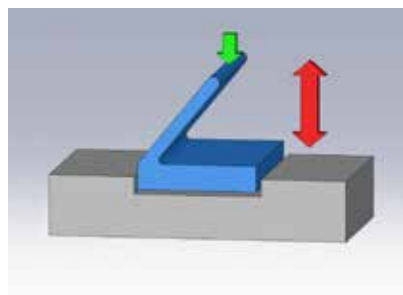

Legend:



EXTRUDED PROFILES

DIFFERENT FASTENING METHODS

1. Bonded profile. Only advisable if strain is not put on the seal too frequently or forcefully and on the condition that adhesion is successful.

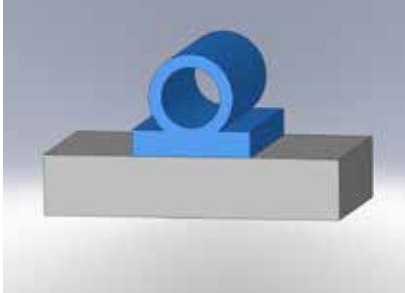

2. Nailed or stapled profile

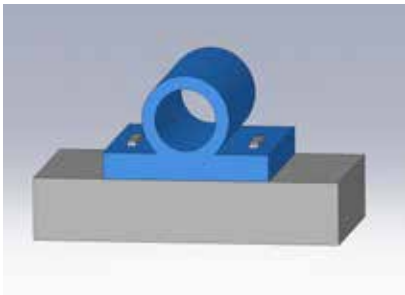

3. Profile to be fitted or bonded in a "push in" groove; the most well-known system.

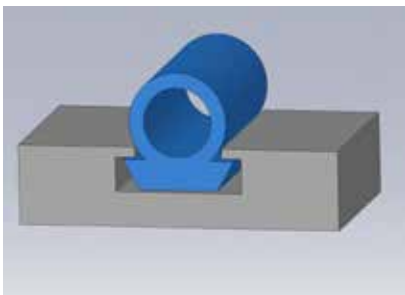

4. Dovetail to wedge or clip in

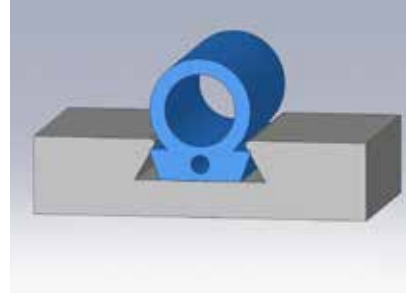

5. Profile to be slipped in

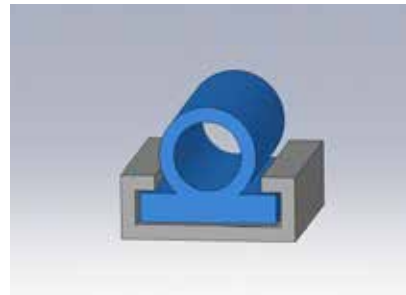

6. Screwed down profile

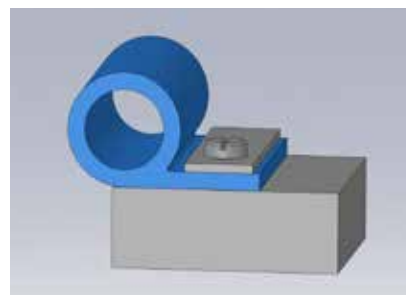





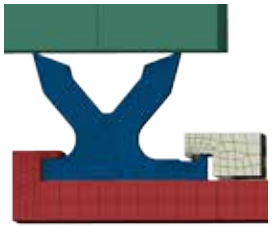
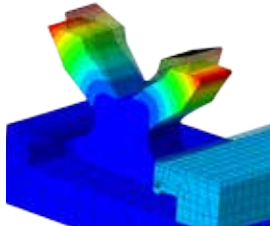

EXTRUDED PROFILES

SPECIFIC DESIGNS ACCORDING TO YOUR NEEDS

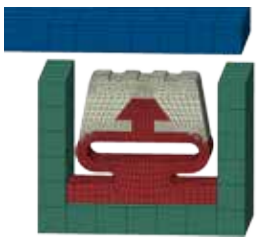
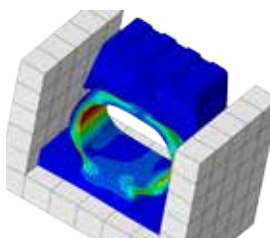
Because elastomers are highly versatile, we are able to define a formulation in accordance with your particular needs and specific conditions for use or implementation. The Technetics Group laboratories allow formulations to be customized and verified to align with your needs.

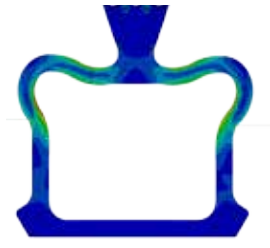









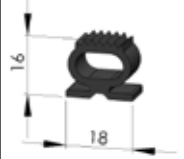
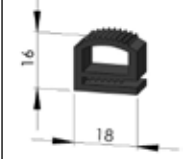
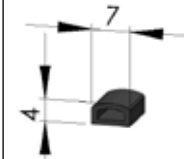
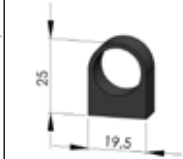

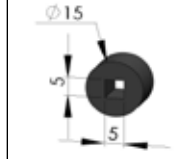
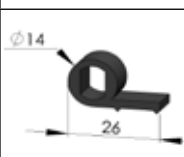
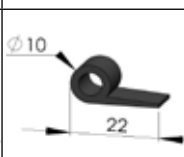
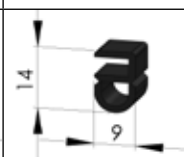
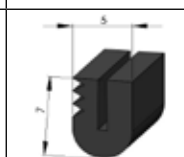
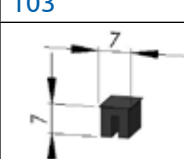
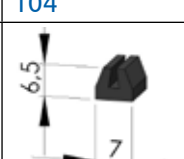
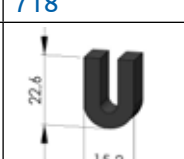

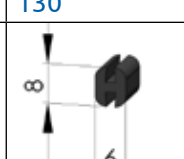
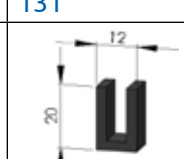
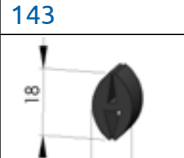
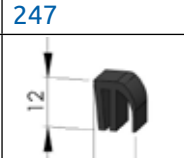
In the same way as the formulations, we design and produce extruded profiles according to your specific plans or specifications (more than 4500 existing profiles). Finite element verification and analysis are also possible with the support of our maestral® sealing laboratory.

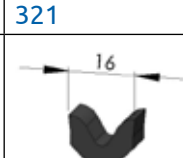
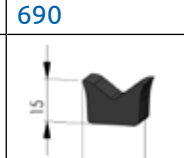
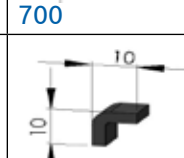
Profile Ref. #	Modeling	Simulation	Production
PI Seal Ref. 3379			
Two-part Inflatable Seal Ref. 2451+3318			
Axial Inflatable Seal Ref. 3316			

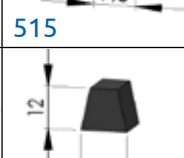
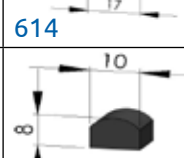
EXTRUDED PROFILES

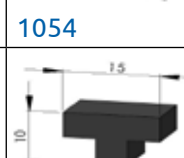
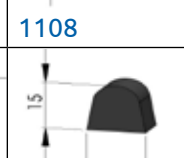
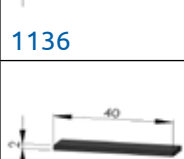
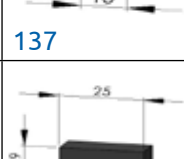
STANDARD DESIGNS

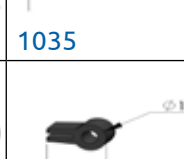
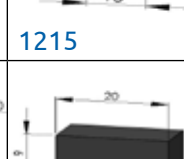
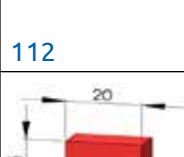
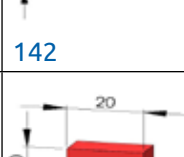
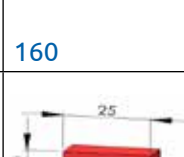
A range of standard profiles is available in stock (properties defined in our data sheets nos. 915-075 and 915-119), completed or produced in accordance with ISO 3302-1 category 2 tolerances.

 113	 139	 166	 565	 1181	 1388
 103	 104	 718	 127	 130	 131
 143	 247	 297	 321	 690	 700
 727	 515	 614	 1053	 1054	 1108
 1136	 137	 138	 607	 1035	 1215
 112	 142	 160	 133	 158	 204
 *872	 *1048	 *1099	 *1364		

MANUFACTURED PARTS

From extruded to molded items, we can produce technical parts manufactured into shapes that meet your specifications.

These products are produced using **Hot Vulcanized Splicing (HVS)**. This joining process uses the same material as that of the extruded or molded item, making the entire product homogeneous (materials, mechanical strength and deformation properties). This ensures the seal will perform optimally.

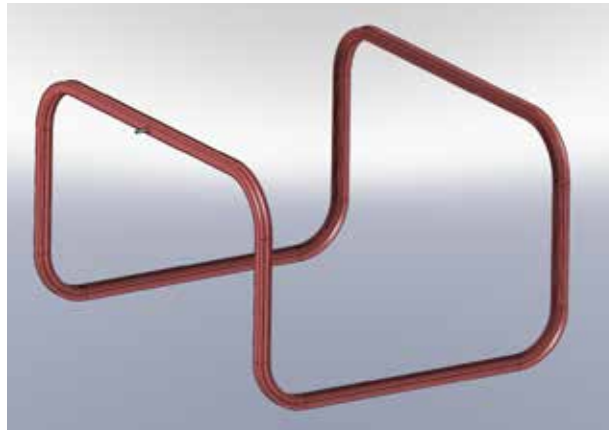
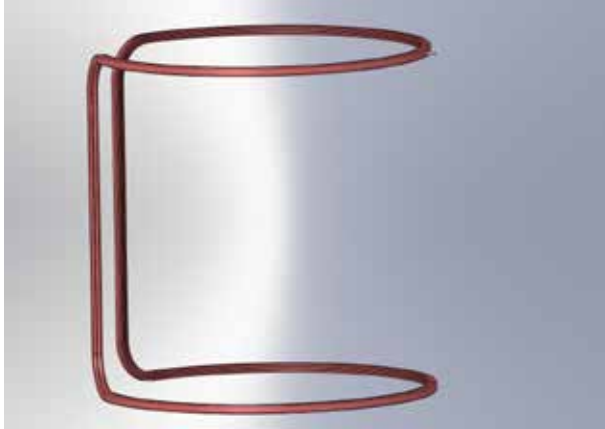

Technetics Group has a wide range of equipment available, making it possible to accommodate various common configurations. Specific equipment can also be developed in order to meet your technical and economic needs.

MOLDED PARTS

Technetics Group also produces technical parts and seals completed using molding (compression, transfer or injection) in accordance with your plans and material specifications or designed following your functional specifications.

The parts can be produced following standard methods and from any type of elastomer (see table on page 2), in accordance with ISO 3302-1 category 2 tolerances, or using more complex methods, implementing inserts in different materials (e.g. aluminum, stainless steel, textiles, glass, etc.).

These parts can also be produced in a controlled environment (dedicated workshop), to meet specific requirements for cleanliness.

Below are just a few examples of specific products we can produce. Our Engineering Department is available to assist with any additional requests that you may have.

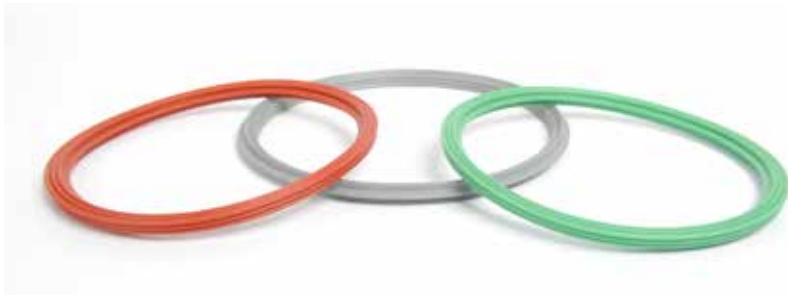

PLATE SEALS

Elastomer seals (FKM, silicone, fluorinated silicone) are overmolded in grooves on anodized aluminum or nickel-plated supports. This enables perfect positioning between elements to be sealed, independently of the orientation and accessibility of the seal.

Our overmolded seals meet the requirements of your critical static and dynamic applications:

- Temperature: from -100°C to +300°C
- Pressure: from vacuum (10⁻⁶ bar) to several hundred bars
- Mediums: variety of atmospheres or fluids (hydrocarbons, bases, acids, corrosive gasses, etc.)



REINFORCED PARTS

Technetics Group designs and produces seals and leak tightness solutions from elastomers reinforced with different types of materials (textiles, metals, composites) for use in critical environments that require high performance:

- Textile: polyester, nylon, glass, ceramic, aramid, etc.
- Metal: inserts and components
- Pre-impregnated composite material (Pre-Preg): structural fabric impregnated with resin

Main applications: aerospace (e.g. aircraft fuselage or fireproof seal), semi-conductor, oil and gas, nuclear, industrial, life sciences

Depending on your performance requirements (EMI), Technetics Group also offers molded or manufactured seals developed from elastomers loaded with metal powders (aluminum, silver, carbon, etc.) or combined with metal braids and knits.



TECHNETICS GROUP

EnPro Industries companies

france@technetics.com

technetics.com

Technetics
GROUP

EnPro Industries companies

O-RINGS

Technetics Group offers products in specific blends for your critical static or dynamic applications, using molded or manufactured (HVS) parts. These round seals are excellent leak-tight systems that can exceed more than 200 bars of operating pressure or reach and maintain primary (10^{-3} bar) to secondary (10^{-6} bar) vacuum levels. For dynamic or relative movement applications, molded solutions are recommended. Additionally, HVS solutions for static uses are highly cost-effective.

DIFFERENT ASSEMBLY OPTIONS

Rectangular groove

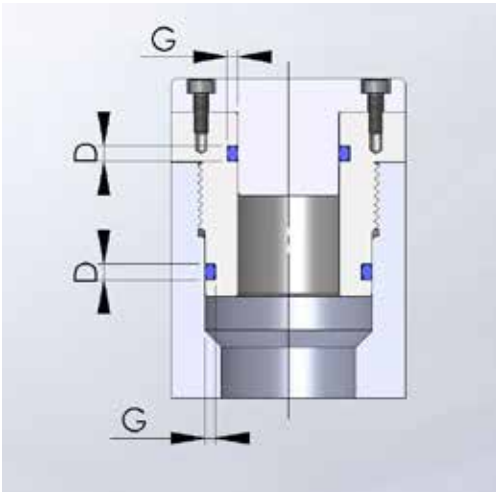
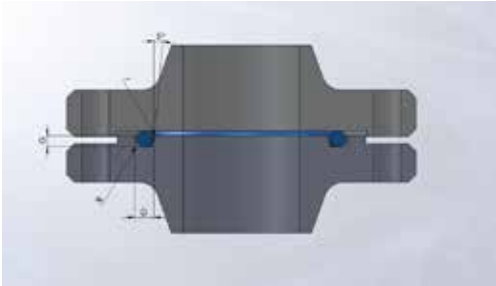

Semi-trapezoidal groove

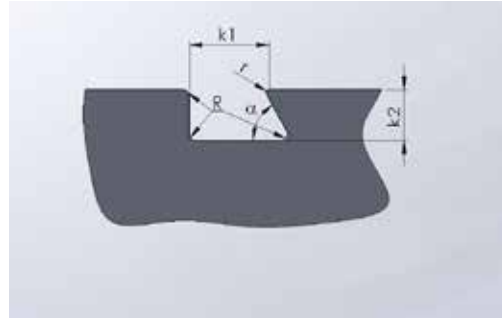

Trapezoidal groove

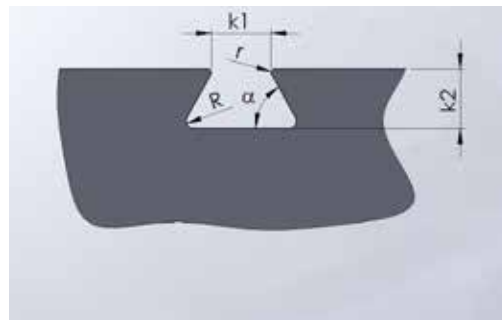

Triangular groove

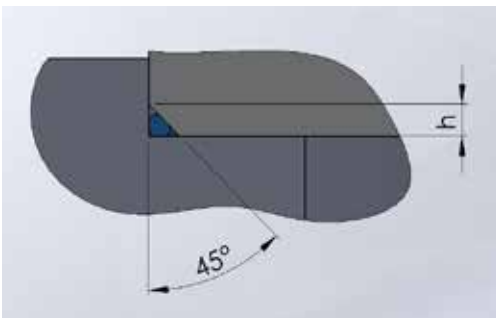

SIZING OF GROOVES AND O-RINGS

Section d. (mm)	Dynamic and static radial		Static axial	
	Groove G depth Tol. +0.05	Groove D width Tol. +0.2	Groove G1 depth Tol. +0.1	Groove D1 width Tol. +0.2
1	0.8	1.3	0.65	1.3
1.27	1	1.5	0.86	1.65
1.52	1.2	1.9	1	2
1.6	1.3	2	1.1	2.2
1.78	1.45	2.2	1.2	2.4
1.9	1.65	2.3	1.4	2.7
2.62/2.7	2.25	3	1.9	3.6
3.53/3.6	3.1	4	2.7	4.8
5.33	4.7	6	4.4	7.2
6.99/7.00	6.1	8	5.8	9.6

SURFACE CONDITIONS

The groove surface must be in very good condition. We recommend machining parts that come into contact with the ring have a surface roughness between 0.8 and 1.6 microns of Ra.

TIGHTENING FORCES

After tightening the O-ring, the parts to be sealed must be in direct contact and their relative position is independent of the seal. In all cases, housings or grooves with a volume 15 to 20% greater than that of the seal ring must be provided. Although elastomers can be deformed geometrically, they cannot be compressed. Leak tightness is obtained via the energy stored in the seal at the moment of deformation.

Contact between the parts being sealed and the seal itself is maintained through elastic memory (compression set). Consequently, there is reason to choose sufficient, but not excessive, deflection rates in order to avoid damaging the O-ring, either through crushing due to lack of room to expand or rapid loss of characteristics due to over-compression. The values of the loads, based on the deflection rates and line diameters, are provided in the table below.

The minimum value of deformation is estimated at 10%, up to a maximum of 35%. For vacuum seals, O-rings must be crushed by 25 to 30%.

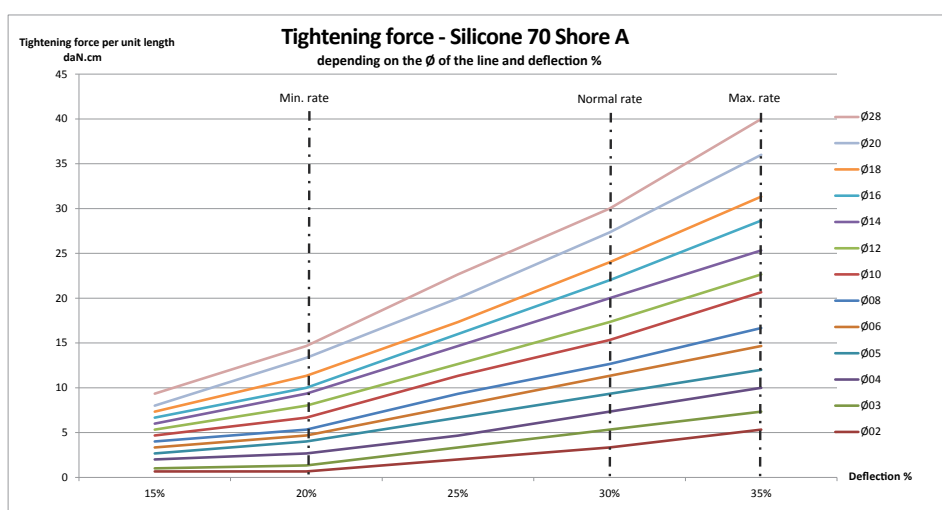

APPLICATIONS

Here are a number of application examples for the sealing solutions previously described.

Markets	Applications
Industrial/Pharmaceutical/Food 	Sealing oven doors: sterilizers, autoclaves, ripening rooms and commercial refrigerators
Nuclear/Aerospace/Industrial 	Frames: windows, sheets of metal
Nuclear/Industrial/Pharmaceutical 	Leak tightness between elements: CEFIL'AIR® inflatable seals, their frequency and speed of disconnection being critical
Industrial / Oil, Gas and Valves 	Static or dynamic sealing: manufactured or molded O-rings, lip rings
Industrial 	Household appliances: sealing and embellishment profiles
Industrial 	Sensors: profiles
Industrial 	Electrical isolation: grommets, profiles, stops, shaped parts
Industrial/Aerospace 	Dielectric isolation: self-fusing tape, sheaths for electrical cables
Industrial 	Plastic industries: Special profiles and endless belts for plastic welding machines Sheaths for cylinders conveying plastic films subjected to HF bombardment (corona effect) for the roughness needed for printing
Food & Beverage 	Food & Beverage industries: Seals "in contact with foods" for sterilization containers, flash-freezing tunnels
Medical 	Medical and paramedical industries: Translucent hoses, multi-way hoses for dental devices Seals for breast pump bottles, etc. Veterinary hypodermic needle seals

For more information on how
Technetics Group affects your critical
markets, visit technetics.com.

ASIA

Blk 203, #05-52
Woodlands Avenue 9
Woodlands Spectrum 2,
738956 Singapore

Phone: +65 6759 2335
Fax: +65 6759 7319

FRANCE

90, rue de la Roche du Geai
CS 52913
42029 Saint Etienne cedex 1 FRANCE

Phone: +33 (0) 4 77 43 51 00
Fax: +33 (0) 4 77 43 51 51

49 Avenue Charles de Gaulle
Z.I. Survaure
42607 Montbrison cedex FRANCE

Phone: +33 (0) 4 77 96 79 80

GERMANY

Falkenweg 1
41468 Neuss
Germany

Phone: 0800-627-0151

UK

Acan Way, Coventry Road
Narborough, Leicester LE19 2FT UK

Phone: +44 (0) 1162 727411
Fax: +44 (0) 1162 727412

USA

2791 The Boulevard
Columbia, SC 29209 USA

Phone: +1-803-783-1880
Fax: +1-803-783-4279

305 Fentress Boulevard
Daytona Beach, FL 32114 USA

Phone: +1-386-253-0628
Fax: +1-386-257-0122

1700 E. International Speedway Blvd
DeLand, FL 32724 USA

Phone: +1-386-736-7373
Fax: +1-386-738-4533

1600 Industry Road
Hatfield, PA 19440 USA

Phone: +1-800-618-4701
Fax: +1-215-855-3570

10633 W Little York, Bldg 3, Suite 300
Houston, TX 77041 USA

Phone: +1-713-983-4201
Fax: +1-713-466-3721

10 Old Webster Road
Oxford, MA 01540 USA

Phone: +1-508-987-5900

990 Richard Avenue, Suite 117
Santa Clara, CA 95050 USA

Phone: +1-669-242-8804
Fax: +1-669-242-8492

TECHNETICS GROUP

EnPro Industries companies

france@technetics.com
technetics.com



EnPro Industries companies