

MACHINED STATIC METAL SEALS CATALOG

STANDARD SEAL SERIES

Technetics
GROUP

EnPro Industries companies



CONTENTS & INTRODUCTION	2
AN INTRODUCTION	3
WHY CHOOSE TECHNETICS?	4
APPLICATIONS, CUSTOMERS, AND LAUNCH VEHICLES	5
1100 SERIES - PRESSURE BALANCED LIQUID TO 1,500 PSI	6
8100 SERIES - PRESSURE ASSISTED LIQUID TO 6,000 PSI	7
9100 SERIES - PRESSURE ASSISTED 10,000 PSI LIQUID/GAS	8
9200 SERIES - PRESSURE ASSISTED METAL O-RING ALTERNATIVE	9
9300 SERIES - PRESSURE ASSISTED 10,000 PSI RUBBER O-RING ALTERNATIVE LIQUID/GAS	10
CUSTOM SEALS	11
SEAL MATERIALS	12
SEAL COATINGS	13
FLANGE LOAD DATA	14
SEAL CAVITIES	15
CAVITY FINISH	16
ORDERING THE 9200 SERIES	17
ORDERING THE 8100, 8101, 9100, 9101, AND 1100 SERIES	18
ORDERING THE 9300 and 9301 SERIES	19



AN INTRODUCTION

To the ultimate in sealing, Technetics Group has developed a unique line of seals specifically designed to utilize the elements of force, fluid and pressure to assist in their solution of sealing.

The patented principles of Technetics Group seals are available as an interchangeable replacement for static "O" rings, or other seal requirements. The dedicated staff at Technetics Group has been designing and manufacturing seals for over five decades. Our seals have gone to the moon and beyond, and to the depths of all our oceans. Our seals have experienced temperatures from -450°F to 2,200°F and pressures to 75,000 psi.



WHY CHOOSE TECHNETICS GROUP?

Technetics Group designed and manufactured metal seals will solve your tough sealing problems. Metal seals are used where other materials are unacceptable:

- Size 1/8 to 45"
- High temperatures up to 2,200°F
- Low temperatures down to -450°F
- Hard vacuum to high pressure
- Extreme environments; corrosive, radioactive, etc
- Reusable in many cases
- Long term sealing; no material degradation
- Infinite storage life

The majority of our seals are static seals; seals that function much like a gasket between two flanges that have little or no relative motion between them. Although we have a variety of standard seals, most of our spacecraft seals are custom designed for a specific application. Custom seal design allows the equipment designer to maximize performance and minimize weight without being constrained by standard seal configurations.



APPLICATIONS

Applications include pumps, valves, flanges and related devices in aircraft, marine, nuclear and space systems. Technetics Group is a major supplier of seals for the Space Shuttle, EELV, and has numerous applications on aircraft engines and satellites.

REPRESENTATIVE CUSTOMER LIST

Some of our customers include the following:

- Atlantic Research
- Ball Aerospace
- Bell Helicopter/Textron
- Boeing Space Systems
- Boeing Aircraft
- DASA
- GenCorp/Aerojet
- Honeywell
- Hughes Space & Communications
- Lockheed Martin
- Moog
- NASA
- Ontario Hydro
- Orbital Sciences
- Pratt & Whitney
- Rocketdyne
- Toyota
- TRW
- United Space Alliance
- Westinghouse
- World Minerals

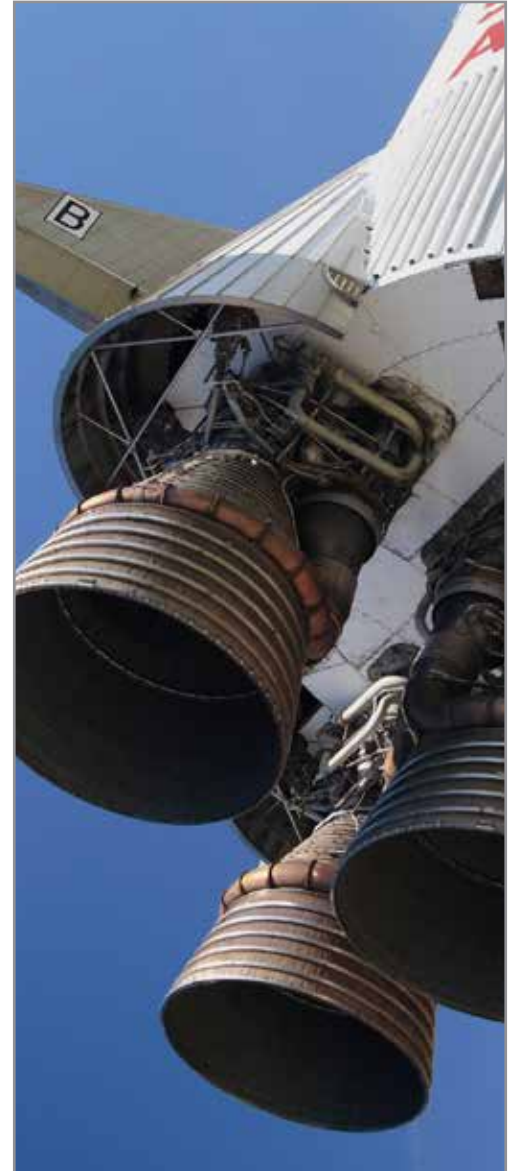

LAUNCH VEHICLES

Mercury, Saturn, Apollo, Atlas, Delta, Titan, Space Shuttle SSME

SPACECRAFT

NASA Satellites, Hubble Telescope, Gravity Probe “B”, Military Satellites

AIRCRAFT

Auxiliary Power Units, SR-71, F-15, V-22

1100 Series Seals

Pressure balanced liquid to 1,500 PSI

SEAL STYLES

Technetics Group manufactures several standardized styles of seals as well as those custom designed for a specific application. The following selection criteria is a guide to assist in seal style choice. You may also contact our application engineers for a recommendation.

1100 SERIES SEAL

The 1100 Series Seal is an external or bellows type, pressure balanced seal. This seal is recommended for liquid systems. It is not recommended for pressure systems above 1,500 psig. For most liquid systems applications however, the 8100 Series seal should be first considered.

LIQUID SERVICE – For liquid systems under 1,500 psi.

LOW FLANGE LOADING – Flange load 75 to 140 pounds per inch of circumference. Will not mark stainless steel flanges.

PRESSURE BALANCED – Seal does not become tighter with increasing pressure and may be used in pressure reversing application.

1100 SERIES

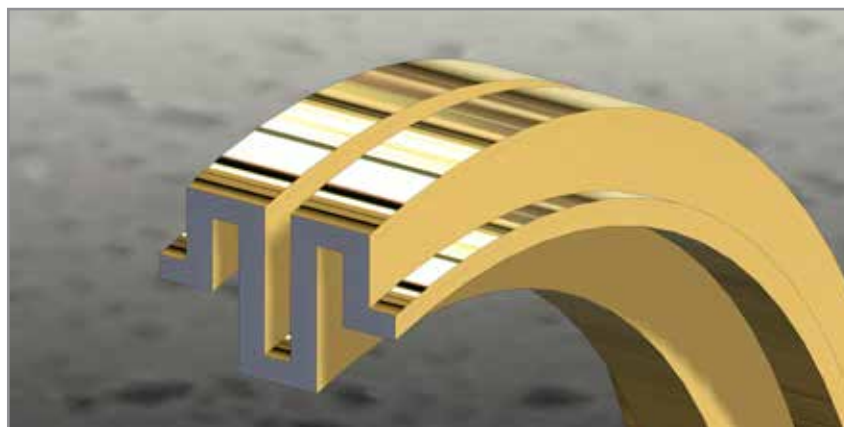

8100 Series Seals

Pressure assisted liquid to 6,000 PSI

8100/8101 SERIES SEAL

The 8100 series seal is an internal or external (8101) pressure assisted seal recommended for liquid systems. The seal is highly reusable and may be proof pressure tested to customer or component requirements. The 8100 series seals work exceptionally well in liquid systems up to 6,000 psi and 1200° F, for requirements above these limits, consult Technetics Group.

For pressure above 1,500 psig and for temperatures above 400°F, diametral clearances between the seal and cavity should be held to .002-.005 tolerance. The 8100 Series Seals have lighter flange loading and greater axial flexibility than most seals.

LIQUID SERVICE – Designed specifically to seal liquids from cryogenic to high temperatures.

LOW FLANGE LOADING – Flange load of 80 to 120 pounds per inch of circumference. Will not mark stainless steel flanges.

PRESSURE ASSISTED – Seal becomes tighter as pressure increases.

HIGH REUSABILITY – Seal may be used many times over.

8100 SERIES

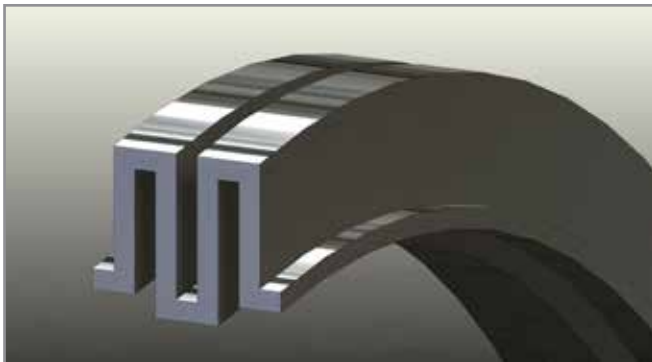

8101 SERIES

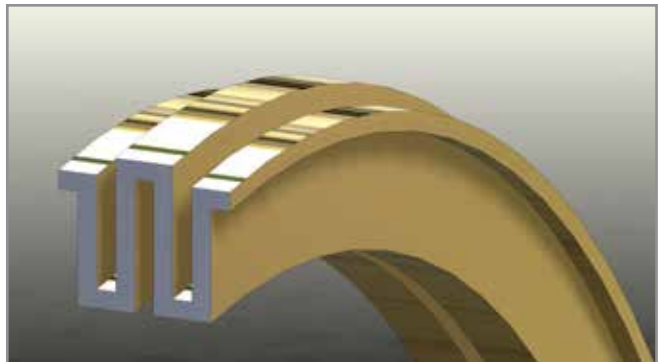

9100 Series Seals

Pressure assisted 10,000 PSI liquid/gas

9100/9101 SERIES SEAL

The 9100 series Seal is an internal or external (9101) pressure assisted seal recommended for liquid, gaseous or multiple phase systems. Operating pressure of this seal is limited only by cavity restraint, (diametrically supported within .002/.005 total clearance). For an unsupported 9100 Series Seal, the pressure limit is 3000 psig. Temperature is limited only by seal and cavity material selection. Flanges may be bottomed out across the O.D. shell of the seal. The bottoming can act as a spacer as well as offering a redundant sealing feature. The 9100 series seals are designed for high interface loading, sufficient to cause localized yielding of seal interface.

LIQUID OR GAS SYSTEMS – Up to 10000 psi.

FLANGE LOAD – Requires 150 to 250 pounds per inch of circumference.

PRESSURE ASSISTED – Seal becomes tighter as pressure increases. 9100 Series for internal pressure; 9101 series for external pressure or internal vacuum.

REUSABLE – Seal may be used many times over.

REDUNDANT SEAL – Seals may be bottomed across heel for a redundant seal. Contact Technetics Group for details.

9100 SERIES

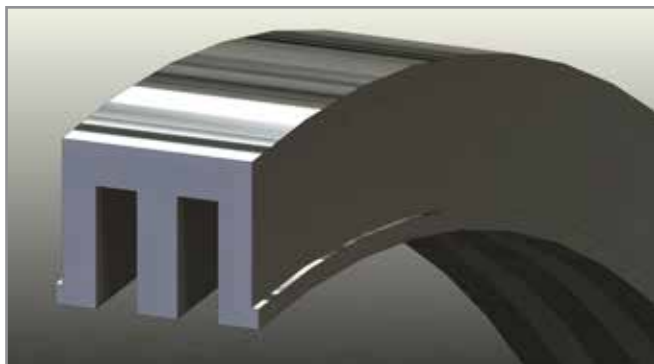

9101 SERIES

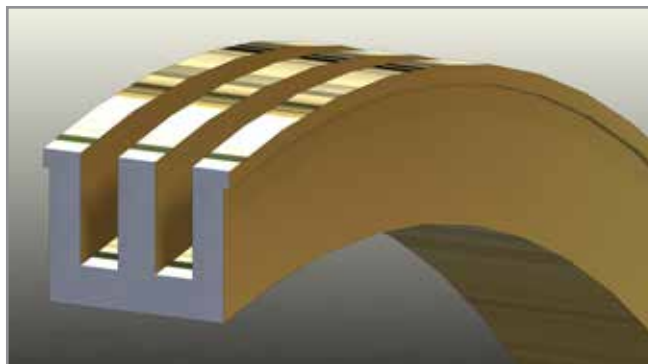

9200 Series Seals

Pressure assisted metal O-ring alternative

9200/9201 SERIES SEAL

The 9200 Series seal is an internal or external (9201) pressure assisted seal designed to be interchangeable with metal "O" rings. The 9200 Requires far less flange loading than metal "O" rings and is highly reusable. The seals may be proof pressure tested to your requirements assuring you of greater quality assurance and reliability. The seals are designed for liquid or gas service with temperature ranges from -450°F to 2,200°F. The 9200 Series seal will not become wedged into its cavity due to deformation common to metal "O" rings and other seas.

LIQUID OR GAS SERVICE – designed to seal both liquids and gases, from cryogenic to high temperatures.

INTERCHANGEABLE WITH METAL "O" RINGS – Designed to function in cavities interchangeable with metal "O" rings.

LOW FLANGE LOAD – Flange load far less than comparable metal "O" ring.

PRESSURE ASSISTED – Seal becomes tighter as pressure increases.

HIGH REUSABILITY – Seal may be used many times over.

9200 SERIES

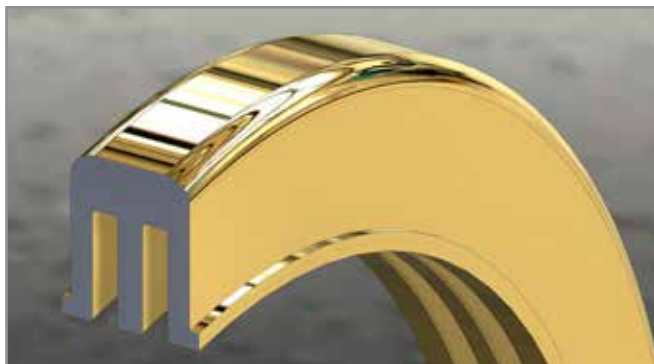

9201 SERIES

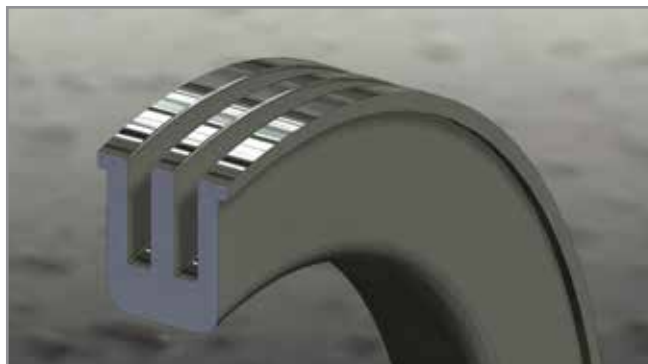

9300 Series Seals

Pressure assisted 10,000 PSI rubber O-ring alternative liquid/gas

9300/9301 SERIES SEAL

9300 for internal pressure, 9301 for external pressure Machined seal cavities designed to replace rubber "O" rings.

LIQUID OR GAS SYSTEMS - Up to 10,000 psi.

PRESSURE ASSISTED - Becomes tighter with increasing pressure.

FLANGE LOAD – Requires 150 to 250 pounds per inch of circumference.

See Table On Pages 18 - 20 For Standard Sizes

9300 SERIES

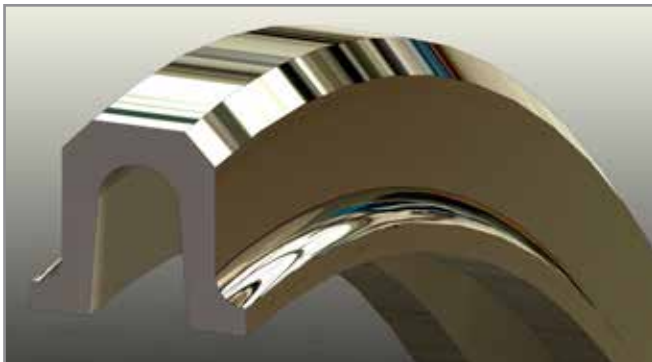

9301 SERIES

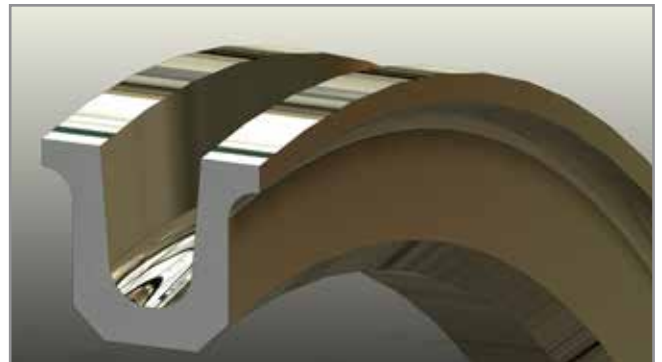

Custom Seals

CUSTOM SEAL

Technetics Group also manufactures a wide variety of custom seals. Any of the series listed can be modified to fit a particular new or existing application. Our engineering staff has decades of experience as well as the resources to test seals in a variety of environments. Our state of the art manufacturing plant is equipped with CNC machining centers and coordinates measurement systems to ensure world quality precision.

Contact Technetics Group for assistance
Refer to our website for engineering support

Technetics Group designs and manufactures custom seals as the configuration of each seal can be optimized for a specific application.

Seal sizes range from 1/4" O.D. to 48" O.D.

Gland size can vary from .050" X.050" to 1.00" x 1.00" or larger.

Wide temperature range -450°F to 2,200°F.

Hard vacuum to high pressure.

Extreme environment: corrosive, radioactive, large gland deflection compatible.

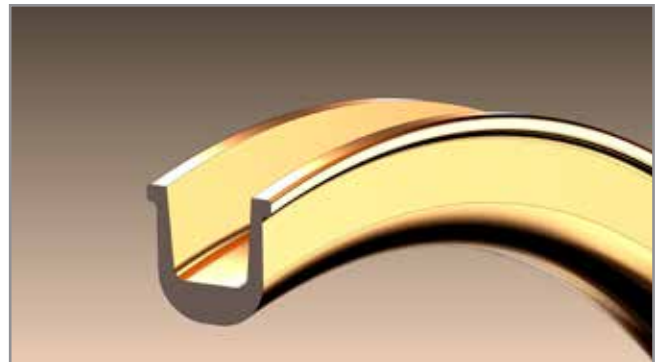

MATERIAL SELECTION

Historically, seals have been manufactured from many materials, including rubber, asbestos, plastics, metals and even paper and leather. The suitability of a given material for a specific application is dependent on its compatibility with the system environment and its ability to seal. In high performance systems which involve corrosive fluids or radiation, metal seals have proven to be effective.

The effectiveness of metal seals depends on selection of a material compatible with the environment and having sufficient strength properties to withstand pressures and temperatures without failure. Technetics Group metal seals are offered in a variety of materials and can be designed and manufactured from any machinable alloy. In general, the seal material which has the highest strength and is still compatible with the system environment will result in the best performance and life with the maximum reliability.

MATERIAL CHARACTERISTICS

Inconel 718

Inconel 718, used in many of our seals, is a high strength, precipitation hardened, corrosion resistant, nickel based super alloy with excellent corrosion resistance, tensile, fatigue, creep and stress rupture properties. It is suitable for use in water, oil, gas, and corrosive fluid systems from temperatures of -450°F to +1,300°F.

Inconel X-750

Inconel X-750 is an age hardened, non magnetic, nickel-chromium-iron alloy with corrosion resistance superior to 300 Series stainless steel and has excellent high temperature oxidation resistance. It is suitable for use in water, oil, gas, and corrosive fluid systems from temperatures of -450°F to +1,200°F.

Material Code Example: 8100-24-0101

Custom 455

Custom 455 is a magnetic, precipitation hardened, nickel-chromium-iron alloy with corrosion resistance superior to type 410 stainless, comparable to Type 430 stainless steel, and will not rust in water. It is suitable for use in water, oil, and gas systems from temperatures from -450°F to +800°F. The strength of Custom 455 is superior to Inconel X-750 and approaches that of VCM 300.

Material Code Example: 8100-24-1201

A-286

A-286 is an iron based heat and corrosion resistant super alloy suited for temperatures down to at least -320°F. The alloy is suitable for moderately corrosive environments.

Technetics Group seals can be coated with a wide variety of materials. Coating selection is usually based on system fluid compatibility and temperature.

COATING SELECTION

To provide an effective leak-tight joint, a seal must block all leak paths between two mating surfaces. Since no two surfaces are perfectly flat or smooth, deformation of the mating materials must take place in order to produce an effective seal. Rubber and other elastomeric materials can easily deform and flow to fill imperfections in mating surfaces. In high performance systems, where solid elastomeric seals fail due to cold flow or nibbing, the metal seal provides sufficient strength to resist gross deformation while the coating provides a thin deformable surface to fill the micro-asperities in the mating surface.

The selection of a suitable coating is dependent on its compatibility with the system environment and its ability to deform and create an effective seal. In general, the coating which has the highest deformability and is still compatible with the system environment will give the best performance and life with maximum reusability.

Gold Plating

Gold plating has excellent corrosion resistance in most fluids including acids and bases. Gold has excellent malleability and provides the most effective high temperature coating. It is suitable for use at temperatures from -450°F to 1,500°F.

Coating Code Example: 8100-24-0103 – (.0003" thick)
8100-24-0104 – (.0010" thick)

Silver Plating

Silver plating has good corrosion resistance, but will oxidize and tarnish in the presence of oxygen. It is less malleable than gold, but will perform satisfactorily in most applications. It is suitable for use at temperatures from -450°F to 1200°F.

Coating Code Example: 8100-24-0101 – (.0003" thick)
8100-24-0102 – (.0010" thick)

PTFE Coating

PTFE coating is inert to most chemicals. It is easily deformed and will provide an effective seal on surfaces too rough or irregular for metallic platings. It is suitable for use at temperatures from -450°F to 480°F.

Coating Code Example: 8100-24-0108 – (.002" thick)

FLANGE LOADING DATA

The information below is presented as a guide to assist in proper flange design. The loads shown are spring loads only and should be added to pressure and thermal loads. For purposes of design, pressure may be considered to act at the seal O.D., with slight error on the conservative side.

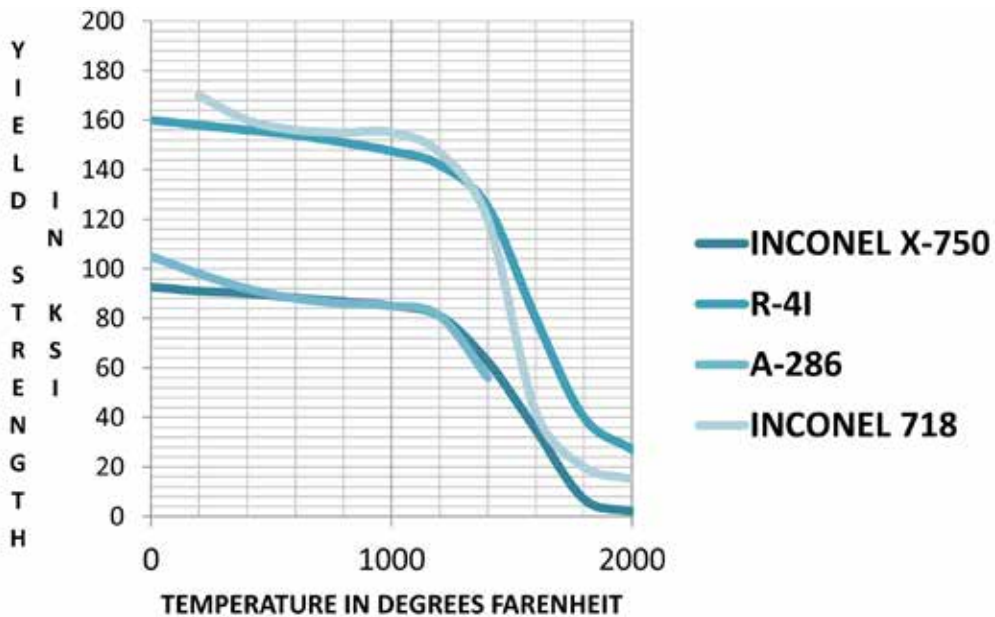
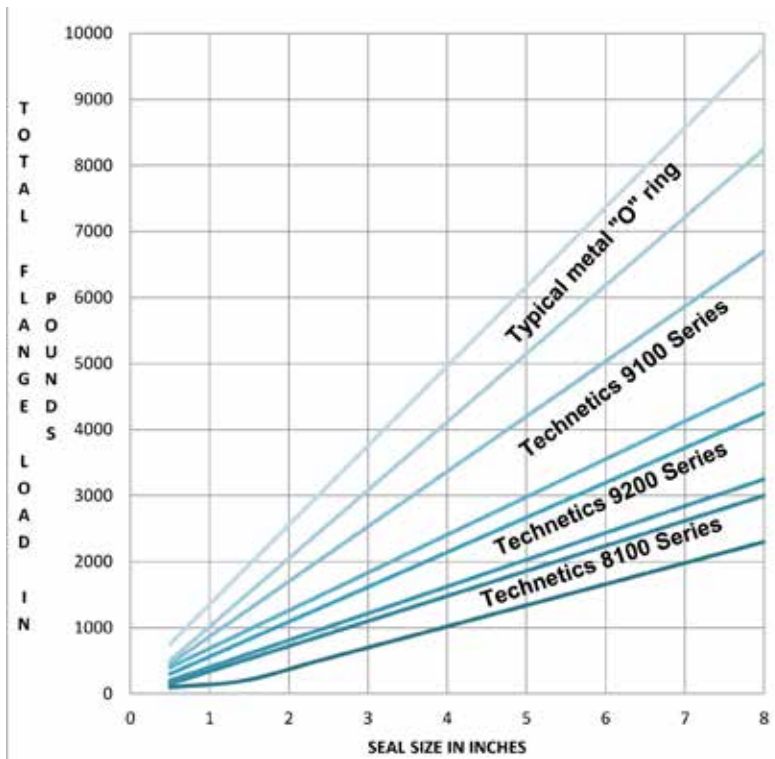

METALLIC SEALS NEED GOOD CAVITIES

The purpose of a seal is to prevent leakage of fluids past a joint. Seals of rubber and soft materials have been used in common applications, their elasticity compensating for irregularities in cavities. In applications involving extremes in temperature, pressure, corrosive fluids, or pressure cycling, soft materials are unsuitable and metallic seals must be used. Metallic seals have less ability than soft materials to compensate for irregular cavities and, thus, cavity design must consider:

- 1) Cavity dimensions
- 2) Cavity surface finish
- 3) Cavity flatness
- 4) Cavity parallelism
- 5) Flange deflection
- 6) Sufficient load to compress seal

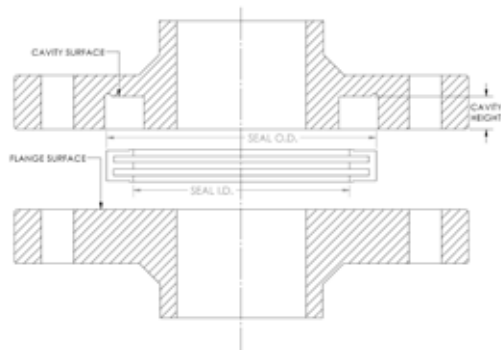

CAVITY DIMENSIONS ARE NOT STANDARDIZED

At the present time, there are no standardized cavities for metallic seals, each manufacturer establishes their own cavity dimensions, Technetics Group can supply seals in special sizes to fit nearly any cavity.

The cavity O.D. supports the seal and adds to its pressure capability. When a seal is pressurized, it expands radially until it fails or it contacts the cavity O.D. The cavity O.D.s shown herein are recommended for systems operating at pressures above 1,500 psi and temperatures above 400°F, which do not experience impulse cycling. Impulse cycling is defined as rapid and repeated changes in seal stresses caused by hydraulic or thermal cycling. For systems which experience impulse cycling, cavity O.D.s should be reduced to a maximum of .002" clearance. For systems below 1,500 psi and 400°F, cavity O.D. is not critical and tolerances may be relaxed. The O.D. edges of 8100 and 9100 Series Seals have square corners. To prevent interference between cavity and seal, cavity corners should be sharp (.003R max). Generally, a lap or grind relief is provided in the cavity to facilitate proper surface generation, eliminating the need for sharp corners.



CAVITY FLATNESS IS NECESSARY

Technetics Group seals are precision finished to exacting flatness. Lack of flatness in a cavity can prevent the seals from making full contact resulting in leakage. For optimum performance with metallic plated seals, cavities should be flat within 4 helium light bands (.000046"). For general service with metallic plated seals, cavity flatness may be within .0002" per inch of circumference. PTFE coated seals will perform satisfactorily on a surface flatness .0005" per inch of circumference.

CAVITY SURFACE FINISH IS CRITICAL

The cavity surface finish is the single most important item in seal performance. Technetics Group seals are designed with sufficient loading to cause seal coatings to flow into cavity micro-asperities and create a seal, but that flow is limited. Pressure and temperature fluctuations cause small movements of the seal relative to the cavity, resulting in wear on the seal and cavity. Proper cavity finishes limit the wear to the ability of the coating to flow and maintain a seal. To obtain optimum performance and reusability with metallic plated seals, cavity finishes should be 12 rms or better. Metallic plated seals will operate on a 16 – 32 rms finish with circular lay, but with reduced performance and reusability. PTFE coated seals will perform satisfactorily on a 32 rms finish, but also with reduced performance and reusability.

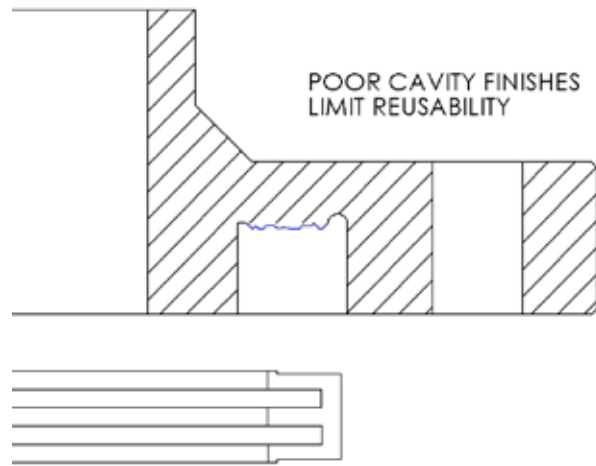
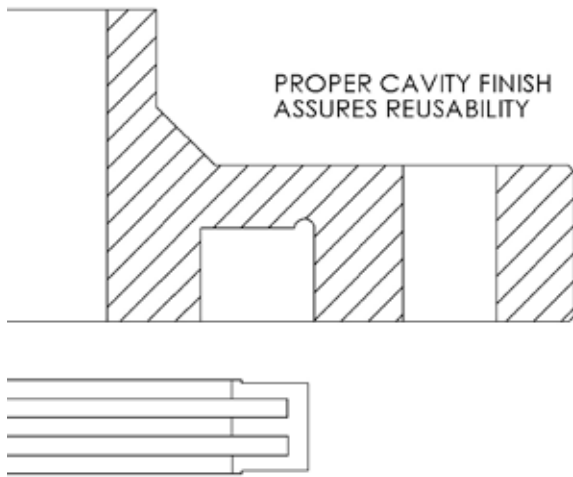

CAVITY PARALLELISM IS IMPORTANT

Technetics Group seals are manufactured to precise parallelism. Lack of parallelism in a cavity can cause excessive loading on one side of the seal and insufficient loading on the other, resulting in poor performance and reliability. For optimum performance with metallic plated seals, cavities should be parallel within .0005". For general service with metallic plated seals and for PTFE coated seals, cavities may be parallel within the tolerance of the cavity height.

FLANGE DEFLECTION MUST BE LIMITED

A proper seal cavity can be produced in the shop, but if it deflects excessively under operating pressures and temperatures, seal failure can result. In designing flanges, the bow between bolts and dishing should be examined in addition to axial and radial deflections to ensure that operating conditions do not alter cavity geometry beyond acceptable limits.

9200 AND THE 9201 SERIES

Cross Section (REF)	Cross Section Code Number	A' Seal O.D. Available Size Range	B' Cavity O.D.	C' Cavity I.D.	D' Cavity Height	E' Cavity Corner Radius
1/16	.062	.250 to 4.000	Nominal Seal O.D. ± .002	Nominal Seal O.D. Minus .143	.042 .045	0.150
3/32	.093	.500 to 8.000	Nominal Seal O.D. ± .002	Nominal Seal O.D. Minus .223	.065 .069	0.020
1/8	.125	.750 to 12.000	Nominal Seal O.D. ± .0025	Nominal Seal O.D. Minus .295	.090 .095	0.030
5/32	1.56	1.000 to 16.000	Nominal Seal O.D. ± .003	Nominal Seal O.D. Minus .364	.115 .120	0.040
3/16	1.87	1.500 to 20.000	Nominal Seal O.D. ± .0035	Nominal Seal O.D. Minus .440	.145 .150	0.050
1/4	.250	2.000 to 24.000	Nominal Seal O.D. ± .004	Nominal Seal O.D. Minus .580	.195 .200	0.060

9200 SERIES

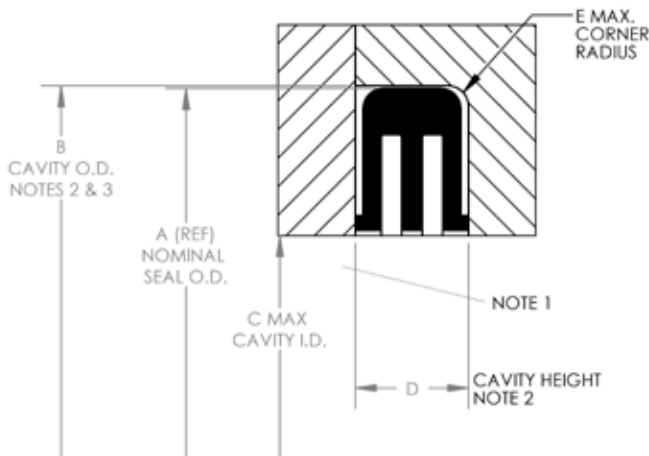

9200 and 9201 Series Notes

- The cavity surface finish should be 12 – 16 rms for metallic plated seals and 32 rms for PTFE coated seals. Faces should be flat within 4 helium light bands and parallel within .0005 inch.
- Cavity O.D. dimensions shown are for systems over 1,500 psi pressure and 400°F temperature.
- Cavity Dimensions shown are for uncoated seals. Add plating or coating thickness for proper dimensions.
- Seals may be supplied in any diameter within the range shown. Specify size by ordering information.
- 9200 series seals may be proof pressure and leak tested to customer requirements. Contact Technetics Group for details.

ORDERING INFORMATION PART NO. CODING & EXAMPLE

EXAMPLE: 9200 SERIES, 3/16" CROSS SECTION, 10.250" NOMINAL SEAL O.D., CUSTOM 455 MATERIAL, PTFE COATED, PRESSURE TEST

See Seal Cavity Considerations for additional information

NOMINAL SEAL O.D. IN THOUSANDTHS OF AN INCH

SERIES NO. → **9200-187-10250-12 08-(T)** ← OPTIONAL PRESSURE TEST

CROSS SECTION CODE NO. → **9200-187-10250-12** MATERIAL CODE NO. **08** COATING CODE NO. **(T)**

ORDERING THE 8100, 8101, 9100, 9101 AND 1100 SERIES

Dash Size No.	'A' Seal O.D.	'B' Cavity O.D.	'C' Cavity I.D.	'D' Cavity Height
-2	.250	.254	.080	.096
-4	.343	.347	.173	.096
-5	.375	.379	.205	.096
-6	.437	.441	.267	.096
-7	.500	.504	.330	.096
-8	.562	.566	.392	.096
-9	.625	.629	.455	.096
-10	.687	.691	.517	.096
-11	.750	.754	.580	.096
-12	.812	.816	.642	.096
-13	.875	.879	.705	.096
-14	.937	.941	.767	.096
-15	1.000	1.004	.830	.096
-16	1.062	1.066	.892	.096
-17	1.125	1.129	.955	.096
-18	1.187	1.191	1.017	.096
-19	1.250	1.254	1.080	.096
-20	1.312	1.316	1.142	.096
-21	1.375	1.379	1.205	.096
-22	1.437	1.441	1.267	.096
-23	1.500	1.504	1.330	.096
-24	1.562	1.566	1.392	.096
-25	1.625	1.629	1.455	.096
-26	1.687	1.691	1.517	.096
-27	1.750	1.754	1.580	.096
-28	1.875	1.875	1.705	.096
-29	2.000	2.004	1.830	.096
-30	2.125	2.129	1.955	.096
-31	2.250	2.254	2.080	.096
-32	2.375	2.379	2.205	.096
-33	2.500	2.504	2.330	.096
-34	2.625	2.629	2.455	.096
-35	2.750	2.754	2.580	.096
-36	2.875	2.879	2.705	.096
-37	3.000	3.004	2.830	.096
-38	3.125	3.129	2.955	.096
-39	3.250	3.254	3.080	.096
-40	3.375	3.279	3.205	.096
-41	3.500	3.504	3.330	.096

SERIES NUMBER

8100
8101
9100
9101
1100

ORDERING INFORMATION PART NO. CODING & EXAMPLE

EXAMPLE: 8100 SERIES, DASH, 18 SIZE, INCONEL X-750 MATERIAL, GOLD PLATING (.0003" THICK), PRESSURE TEST

8100-18-01-03 (T)

Material Code Number	Material
01XX	INCONEL X-750
02XX	A-286
03XX	INCONEL 718

Coating Code Number	Coating	Nominal Thickness
XX00	None	
XX01	Silver	.0003"
XX02	Silver	.0010"
XX03	Gold	.0003"
XX04	Gold	.0010"
XX08	PTFE	.0020"

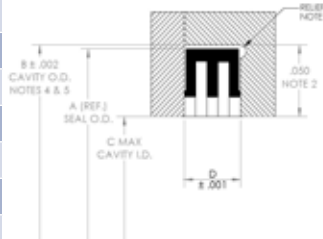

Dash Size No.	'A' Seal O.D.	'B' Cavity O.D.	'C' Cavity I.D.	'D' Cavity Height
-42	3.625	3.630	3.405	0.106
-43	3.750	3.755	3.530	0.106
-44	3.875	3.880	3.655	0.106
-45	4.000	4.005	3.780	0.106
-46	4.250	4.255	4.030	0.106
-47	4.500	4.505	4.280	0.106
-48	4.750	4.755	4.530	0.106
-49	5.00	5.005	4.780	0.106
-50	5.250	5.255	5.030	0.106
-51	5.500	5.505	5.280	0.106
-52	5.750	5.755	5.530	0.106
-53	6.000	6.005	5.780	0.106
-54	6.250	6.255	6.030	0.106
-55	6.500	6.505	6.280	0.106
-56	6.750	6.755	6.530	0.106
-57	7.000	7.005	6.780	0.106
-58	7.250	7.255	7.030	0.106
-59	7.500	7.505	7.280	0.106
-60	7.750	7.755	7.530	0.106
-61	8.000	8.005	7.780	0.106
-62	8.250	8.255	8.030	0.106

DIMENSIONS

Seal Dash Numbers	'B' Min Cavity Radial Width	'L' Cavity Depth	'R' Max Cavity Corner Radius	'S' (REF) Seal Radial Width
006 thru 036	0.095	.061/.062	0.010	0.070
117 thru 159	0.140	.081/.083	0.015	0.105
217 thru 284	0.187	.111/.113	0.020	0.150

MATERIALS

Material Code No.	Material
01XX	INCONEL X-750
02XX	A-286
03XX	INCONEL 718
04XX	RENE' 41
05XX	SPECIAL ORDER
06XX	WASPALOY
07XX	17-4PH
08XX	-NOTUSED-
09XX	INCOLOY 909
10XX	17-7 PH
11XX	MARAGING STEEL

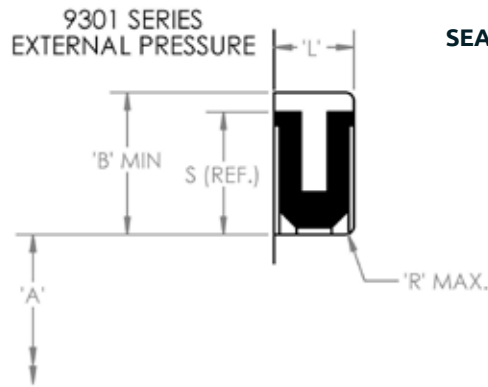

PART NO. CODING & EXAMPLE

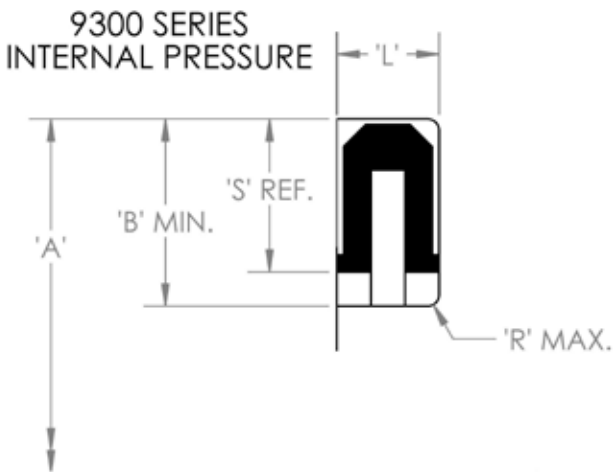

COATINGS

Coating Code No.	Coating	Thickness
XX00	None	
XX01	Silver	.0003"
XX02	Silver	.0010"
XX03	Gold	0003"
XX04	Gold	0010"
XX05	SPECIAL ORDER	
XX06	Recrystallized Nickel	0003"
XX07	Recrystallized Nickel	0010"
XX08	PTFE	0020"
XX09		
XX10		

ORDERING THE 9300 AND 9301 SERIES

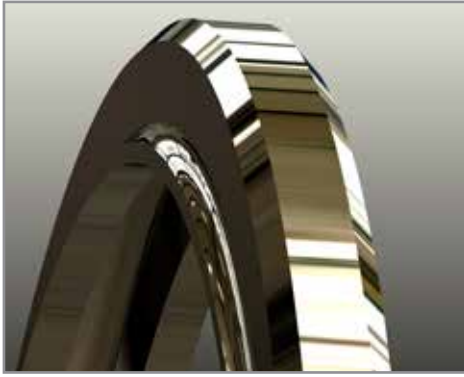

Seal Dash No.	9300 Series 'A' Cavity O.D. ± .002	9301 Series 'A' Cavity I.D. ± .002
006	0.254	0.114
007	0.285	0.145
008	0.316	0.176
009	0.348	0.208
010	0.379	0.239
011	0.441	0.301
012	0.504	0.364
013	0.566	0.426
014	0.629	0.489
015	0.691	0.551
016	0.754	0.614
017	0.816	0.679
018	0.879	0.739
019	0.941	0.801
020	1.004	0.864
021	1.066	0.926
022	1.129	0.989
023	1.191	1.051
024	1.254	1.114
025	1.316	1.176
026	1.379	1.239
027	1.441	1.301
028	1.504	1.364
029	1.629	1.489
030	1.754	1.614
031	1.879	1.739
032	2.004	1.864
033	2.129	1.989
034	2.254	2.114
035	2.379	2.239
036	2.504	2.364

Seal Dash No.	9300 Series 'A' Cavity O.D. ± .003	9301 Series 'A' Cavity I.D. ± .003
117	1.005	0.799
118	1.068	0.862
119	1.130	0.924
120	1.193	0.987
121	1.255	1.049
122	1.318	1.112
123	1.380	1.174
124	1.443	1.237
125	1.505	1.299
126	1.568	1.362
127	1.630	1.424
128	1.693	1.487
129	1.755	1.549
130	1.818	1.612
131	1.880	1.674
132	1.943	1.737
133	2.005	1.799
134	2.068	1.862
135	2.131	1.925
136	2.193	1.987
137	2.256	2.050
138	2.318	2.112
139	2.381	2.175
140	2.443	2.237
141	2.506	2.300
142	2.568	2.362
143	2.631	2.425
144	2.693	2.487
145	2.756	2.550
146	2.818	2.612
147	2.881	2.674
148	2.943	2.737
149	3.006	2.800
150	3.068	2.862
151	3.193	2.987
152	3.443	3.237
153	3.693	3.487
154	3.943	3.737
155	4.193	3.987
156	4.443	4.237
157	4.693	4.487
158	4.943	4.737
159	5.193	4.987

ORDERING THE 9300 AND 9301 SERIES

Seal Dash No.	9300 Series 'A' Cavity O.D. ± .004	9301 Series 'A' Cavity O.D. ± .004
217	1.449	1.171
218	1.512	1.234
219	1.574	1.296
220	1.637	1.359
221	1.700	1.421
222	1.762	1.484
223	1.887	1.609
224	2.012	1.734
225	2.137	1.859
226	2.262	1.984
227	2.387	2.109
228	2.512	2.234
229	2.637	2.359
230	2.762	2.484
231	2.887	2.609
232	3.012	2.734
233	3.137	2.859
234	3.262	2.984
235	3.387	3.109
236	3.512	3.234
237	3.637	3.359
238	3.762	3.484
239	3.887	3.609
240	4.012	3.734
241	4.137	3.859
242	4.262	3.984
243	4.387	4.109
244	4.512	4.234
245	4.637	4.359
246	4.762	4.484
247	4.887	4.609
248	5.012	4.734
249	5.137	4.859
250	5.262	4.984

Seal Dash No.	9300 Series 'A' Cavity O.D. ± .004	9301 Series 'A' Cavity O.D. ± .004
251	5.387	5.109
252	5.512	5.234
253	5.637	5.359
254	5.762	5.484
255	5.887	5.609
256	6.012	5.734
257	6.137	5.859
258	6.262	5.984
259	6.512	6.234
260	6.762	6.484
261	7.012	6.734
262	7.262	6.984
263	7.512	7.234
264	7.762	7.484
265	8.012	7.734
266	8.262	7.984
267	8.512	8.234
268	8.762	8.484
269	9.012	8.734
270	9.262	8.984
271	9.512	9.234
272	9.762	9.484
273	10.012	9.734
274	10.262	9.984
275	10.762	10.484
276	11.262	10.984
277	11.762	11.484
278	12.262	11.984
279	13.262	12.984
280	14.262	13.984
281	15.262	14.984
282	16.233	15.955
283	17.233	16.955
284	18.233	17.955

THE TECHNICAL DATA CONTAINED HEREIN IS BY WAY OF EXAMPLE AND SHOULD NOT BE RELIED ON FOR ANY SPECIFIC APPLICATION. TECHNETICS GROUP WILL BE PLEASED TO PROVIDE SPECIFIC TECHNICAL DATA OR SPECIFICATIONS WITH RESPECT TO ANY CUSTOMER'S PARTICULAR APPLICATIONS. USE OF THE TECHNICAL DATA OR SPECIFICATIONS CONTAINED HEREIN WITHOUT THE EXPRESS WRITTEN APPROVAL OF TECHNETICS GROUP IS AT USER'S RISK AND TECHNETICS GROUP EXPRESSLY DISCLAIMS RESPONSIBILITY FOR SUCH USE AND THE SITUATIONS WHICH MAY RESULT THEREFROM.

TECHNETICS GROUP MAKES NO WARRANTY, EXPRESS OR IMPLIED, THAT UTILIZATION OF THE TECHNOLOGY OR PRODUCTS DISCLOSED HEREIN WILL NOT INFRINGE ANY INDUSTRIAL OR INTELLECTUAL PROPERTY RIGHTS OF THIRD PARTIES.

TECHNETICS GROUP IS CONSTANTLY INVOLVED IN ENGINEERING AND DEVELOPMENT. ACCORDINGLY, TECHNETICS GROUP RESERVES THE RIGHT TO MODIFY, AT ANY TIME, THE TECHNOLOGY AND PRODUCT SPECIFICATIONS CONTAINED HEREIN.

ALL TECHNICAL DATA, SPECIFICATIONS AND OTHER INFORMATION CONTAINED HEREIN IS DEEMED TO BE THE PROPRIETARY INTELLECTUAL PROPERTY OF TECHNETICS GROUP. NO REPRODUCTION, COPY OR USE THEREOF MAY BE MADE WITHOUT THE EXPRESS WRITTEN CONSENT OF TECHNETICS GROUP.



For more information on how
Technetics Group affects your critical
markets, visit technetics.com.

ASIA

Blk 203, #05-52
Woodlands Avenue 9
Woodlands Spectrum 2,
738956 Singapore

Phone: +65 6759 2335
Fax: +65 6759 7319

FRANCE

90, rue de la Roche du Geai
CS 52913
42029 Saint Etienne cedex 1 FRANCE

Phone: +33 (0) 4 77 43 51 00
Fax: +33 (0) 4 77 43 51 51

49 Avenue Charles de Gaulle
Z.I. Survaure
42607 Montbrison cedex FRANCE

Phone: +33 (0) 4 77 96 79 80

GERMANY

Falkenweg 1
41468 Neuss
Germany

Phone: 0800-627-0151

UK

Acan Way, Coventry Road
Narborough, Leicester LE19 2FT UK

Phone: +44 (0) 1162 727411
Fax: +44 (0) 1162 727412

USA

2791 The Boulevard
Columbia, SC 29209 USA

Phone: +1-803-783-1880
Fax: +1-803-783-4279

305 Fentress Boulevard
Daytona Beach, FL 32114 USA

Phone: +1-386-253-0628
Fax: +1-386-257-0122

1700 E. International Speedway Blvd
DeLand, FL 32724 USA

Phone: +1-386-736-7373
Fax: +1-386-738-4533

1600 Industry Road
Hatfield, PA 19440 USA

Phone: +1-800-618-4701
Fax: +1-215-855-3570

10633 W Little York, Bldg 3, Suite 300
Houston, TX 77041 USA

Phone: +1-713-983-4201
Fax: +1-713-466-3721

10 Old Webster Road
Oxford, MA 01540 USA

Phone: +1-508-987-5900

831 Bransten Road
San Carlos, CA 94070 USA

Phone: +1-650-594-9797
Fax: +1-650-594-9620

TECHNETICS GROUP

EnPro Industries companies

deland@technetics.com
technetics.com

Technetics
GROUP

EnPro Industries companies